

FILE AMEND NOTE	DATE	REV.
ORIGINAL EDITION	2012/10/24	A/0

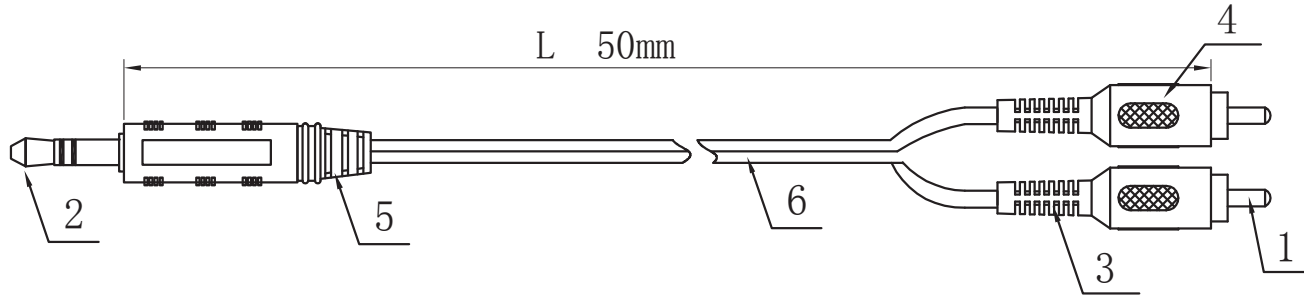

SPECIFICATION

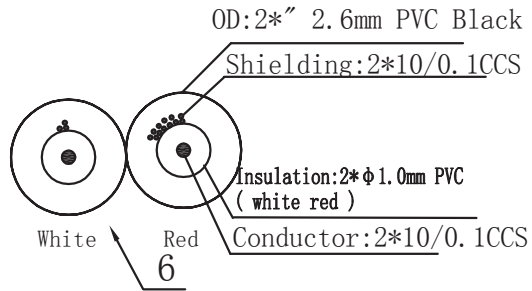

WIRING DIAGRAM

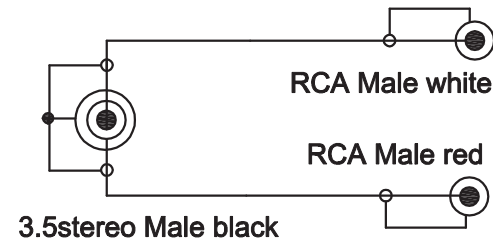

NOTE:

Electrical test
100% open short & miss wire test;

MATERIAL LIST

NO.	ITEM NO.	EAN CODE:	L
1	CA1042	4052792008760	1,5m
2	CA1043	4052792008777	5,0m

NOTE:

1. TESTING: 100% OPEN AND SHORT AND MISWIRE TEST.
2. INSULATION RESISTANCE: 100Meg Ohm.
3. WITHSTAND VOLTAGE: 500 VOLTS RMS, 1 MINUTE.
4. OPERATING TEMPERATURE RANGE: -20 ! TO + 75! .
5. 100% RoHS COMPLIANT.

No.	PART NAME	DESCRIPTION	QTY	REMARK	APPROVE BY	CHECK BY	DRAW BY	SCALE	MM
⑧	PRINTING								
⑦	POLY BAG	PE, COLOR: TRANSPARENT	1						
⑥	CABLE	2C AUDIO CABLE Cold Black	L						
⑤	MOLD HOOD	PVC 45P Cold Black							
④	MOLD HOOD	PVC 45P Cold red	1		DRAW No.	2D-AV-005	NAME	Audio cable, 1X3,5mm male to 2x Cinch male	
③	MOLD HOOD	PVC 45P Cold white	1		CUSTOMER		MAPE	TOLERANCE	
②	CONNECTOR	3.5STEREO Male NI	1		CUSTOMER No.	2D irect Gm bh		X. 1.00	X.X 0.50
①	CONNECTOR	RCA Male NI	1						
No.	PART NAME	DESCRIPTION	QTY	REMARK				PAGE	1/2

FILE AMEND NOTE	DATE	REV.
ORIGINAL EDITION	2012/10/24	A/0

PACKING DRAW



1PCS/BAG

⑥

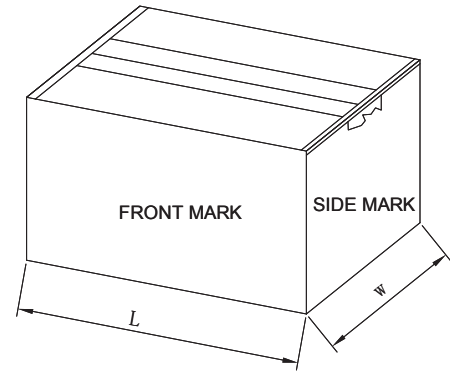
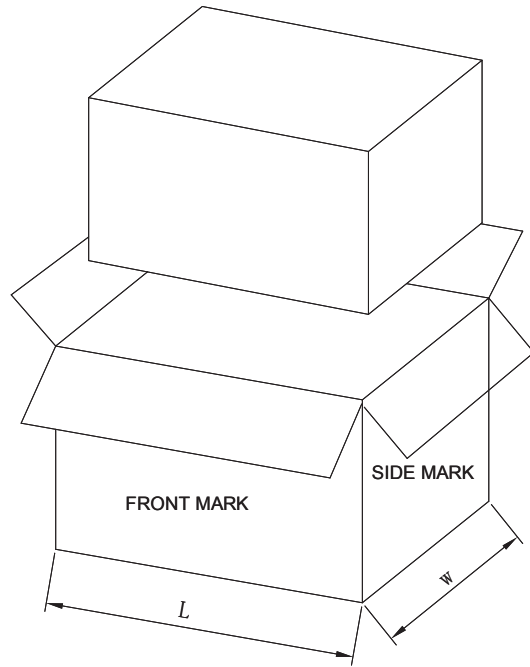
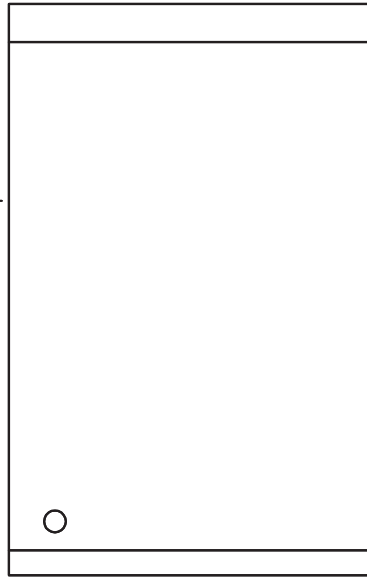

!~# shaped packaging
three packaging tape

STICKER

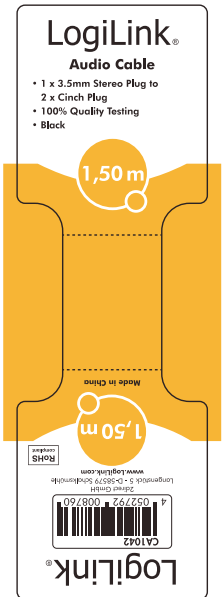

OUTER CARTON
FRONT MARK:

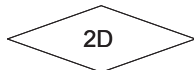

GERMANY
C/NO.:DW 01,02...
MADE IN CHINA

OUTER CARTON
SIDE MARK:

PO NO.:
ITEM NO.:
Q TY: PCS
N.W: KGS
G.W: KGS
Dimension:
EAN CODE:

NOTE:
Electrical test
100% open short & miss wire test;

DRAW No.	NAME	Audio cable, 1X3,5mm male to 2x Cinch male		
CUSTOMER	2direct GmbH	MAPE	TOLERANCE	
CUSTOMER No.			X. 1.00	X.X 0.50
APPROVE BY	CHECK BY	DRAW BY	SCALE	MM
			PAGE	2/2

No.	PART NAME	DESCRIPTION	QTY	REMARK
-----	-----------	-------------	-----	--------

Pantone 1235C, Black
Size: 48x150 mm R= 2mm
材質: 80P銅版紙, 上完PP(光膜)