

Bushless version

FEATURES

- Carbon resistive element
- Dust proof enclosure
- Polyester substrate
- Modular gang type (up to 4)
- Self extinguishable material UL 94-V0
- Upon request:
 - Metallic support
 - Stereo matching
 - Switch
 - Nut & washer
 - Bushless option available

MECHANICAL SPECIFICATIONS

- Mechanical rotation angle: $300^\circ \pm 5^\circ$
- Electrical rotation angle: $280^\circ \pm 20^\circ$
- Torque: 0.5 to 1.5 Ncm.
(0.7 to 2.1 in-oz)
- Stop torque: > 40 Ncm. (>56 in-oz)
- Max. torque nut (binding out): < 80 Ncm. (112 in-oz)
- Thrust and pull in the shaft: > 25 N

ELECTRICAL SPECIFICATIONS

- Range of values (*)
 - $100\Omega \leq R_n \leq 5\text{ M}$ (Decad. 1.0 - 2.0 - 2.2 - 2.5 - 4.7 - 5.0)
 - Tolerance (*): $100\Omega \leq R_n \leq 1\text{M}\Omega$ $\pm 20\%$
 $1\text{M}\Omega < R_n \leq 5\text{M}\Omega$ $\pm 30\%$
 - Max. Voltage: 250 VDC (lin) 125 VDC (no lin)
 - Nominal Power 50°C (122°F) (see power rating curve)
0.2 W (lin) 0.1 W (no lin)
 - Taper (*) (Log. & Alog. only $R_n > 1\text{K}$) Lin ; Log; Alog.
 - Residual resistance(*): $\leq 0.5\% R_n$ (5 Ω min.)
 - Equivalent Noise Resistance: $\leq 3\% R_n$ (3 Ω min.)
 - Operating temperature**: $-25^\circ\text{C} + 70^\circ\text{C}$ ($-13^\circ\text{F} + 158^\circ\text{F}$)
- * Others upon request ** Up to 85°C depending on application

HOW TO ORDER

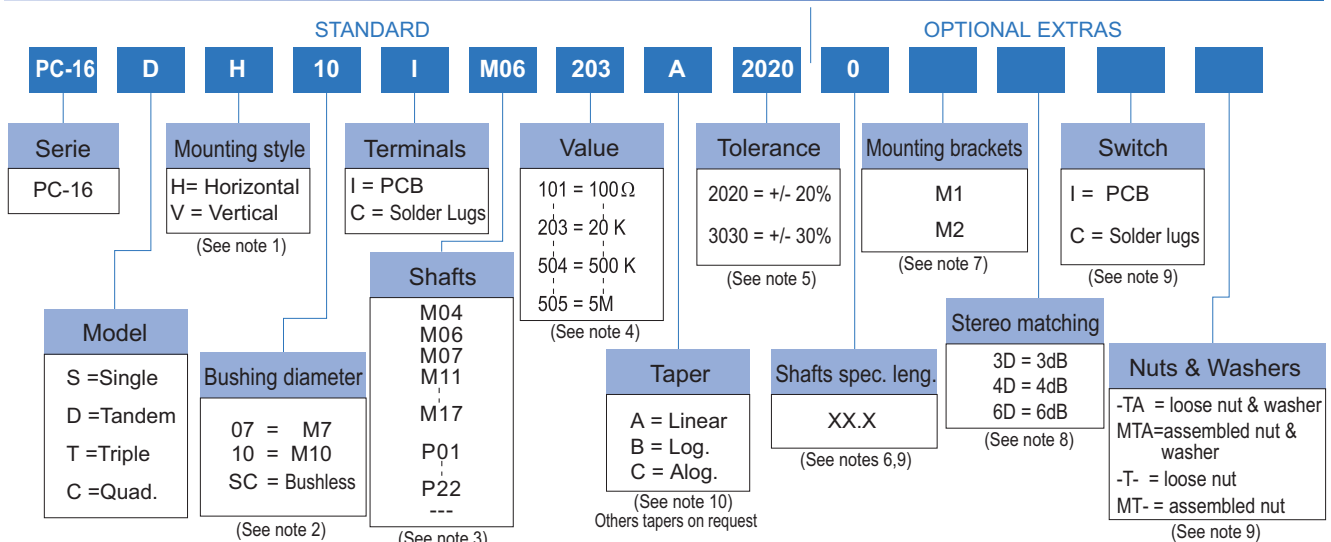

NOTES:

- (1) Mounting style: Type "V" is only available in model "S" potentiometer and with printed circuit terminals.
- (2) Bushings: Type "10" has two parallel flat surfaces for avoiding rotation. Bushless option only available for single model.
- (3) M07 shaft is only available with M10 bushing. --- = no shaft
- (4) Value: • Code: $\overset{10}{\text{---}} \overset{1}{\text{---}} \overset{100}{\text{---}} \Omega$
 → Number of zeros
 → 2 first digits of the value.
 • In models "D", "T", "C", with different values, they will be asked by drawings.
- (5) Tolerance (non standard), upon request. Example: +7% Code: $\overset{07}{\text{---}} \overset{05}{\text{---}}$
 → negative tolerance
 → positive tolerance
- (6) Shaft special length:
 • Only for special length and plain shafts (not knurled). Example: Shaft $\varnothing 6.35$ L = 24.5 $\overset{M07}{\text{---}} \dots \overset{24.5}{\text{---}}$
 • NOTE: Maximum length recommended: L = 45
 → special length shafts
- (7) Mounting brackets: Only applicable for model "S", mounting "H" and without switch.
- (8) Stereo matching: not available for single models. Maximum will be: • 3dB for model "D" • 4dB for model "T" • 6dB for model "C"
- (9) Not available for Bushless version.
- (10) Switch option not available with antilog taper.

NOTE: The information contained here should be used for reference purposes only.

HOW TO ORDER CUSTOM DRAWING

PC-16 S V + DRAWING NUMBER (Max. 16 digits)

This way of ordering should be used for options which are not included in the "How to order" standard and optional extras.

STANDARD OPTIONS

Shaft length 0 Standard Length
 Mounting brackets Without mounting brackets
 Stereo matching Only on request (see note 8)
 Switch No switch
 Nut & washer Without nut and washer

MODELS

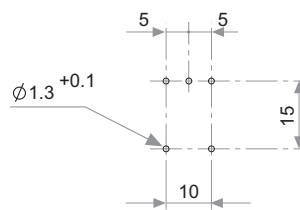
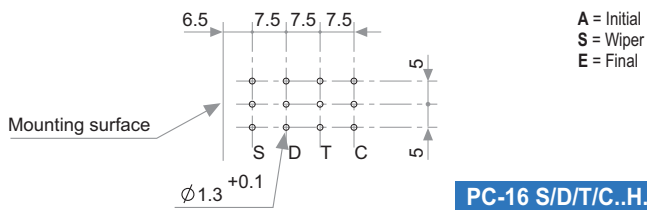
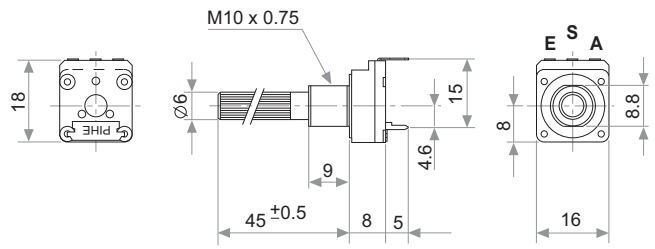
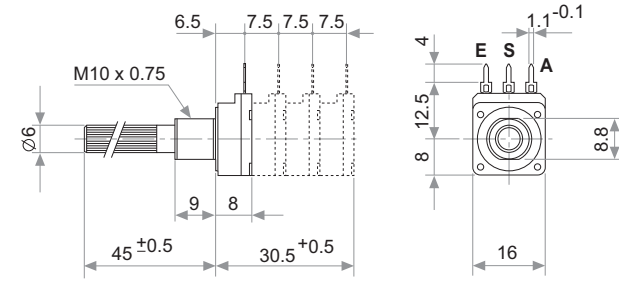

A = Initial
 S = Wiper
 E = Final

PC-16 S/D/T/C..H...

PC-16 SV

METALLIC SUPPORT

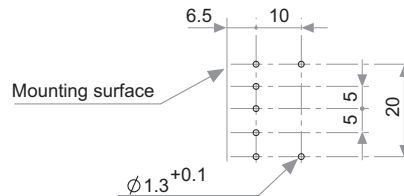
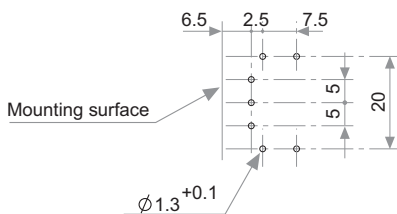
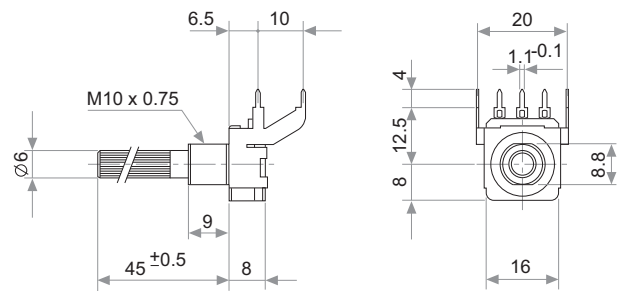
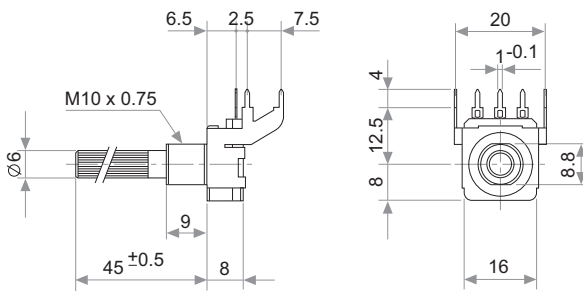

PC-16 SH.....M1

PC-16 SH....M2

BUSHINGS

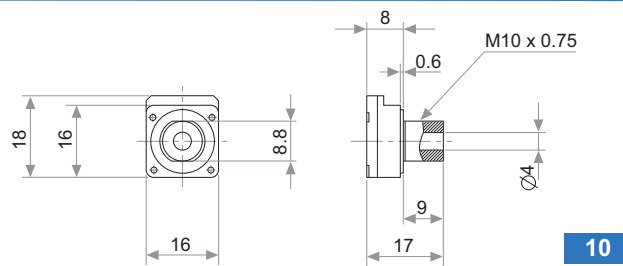
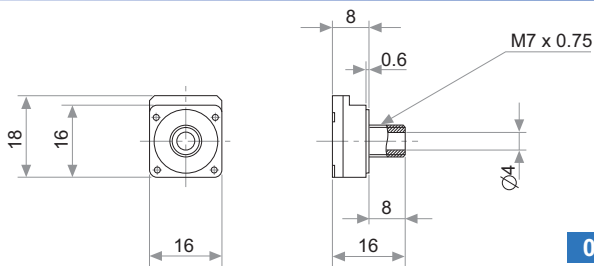

07

10

EXAMPLES OF BUSHLESS VERSION

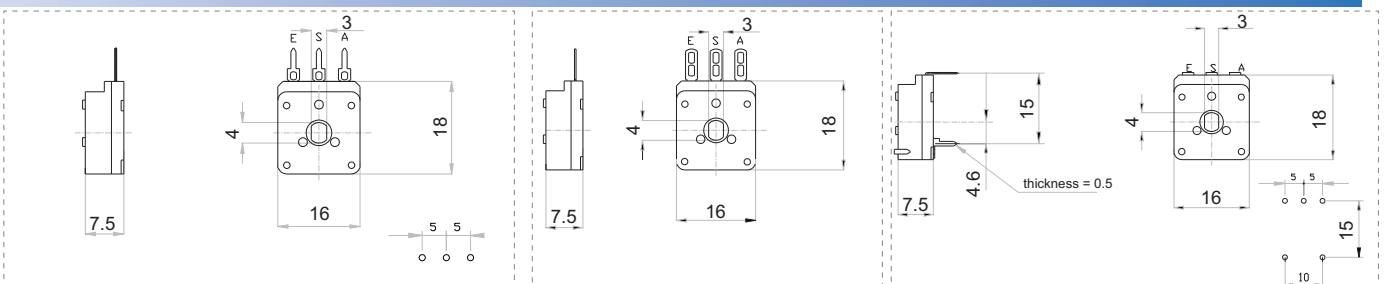

TERMINALS



TAPERS

Standard

A = Linear
B = Log.
C = Alog.

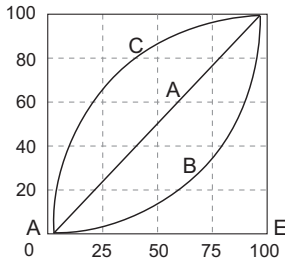

POWER RATING CURVE

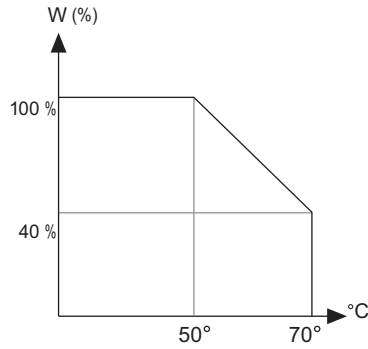

NUTS & WASHERS

Bushing 10

Bushing 07

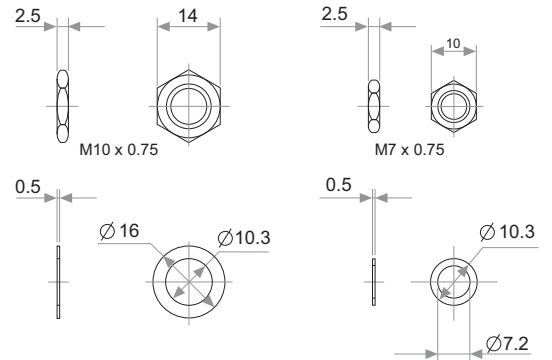

NOTE = Please note relative terminal positions when ordering non linear tapers.

TESTS

TYPICAL VARIATIONS

| | | |
|----------------------------------|--|---------------------------|
| ELECTRICAL LIFE | 1.000 h. @ 50°C; 0.2 W | ±5 % |
| MECHANICAL LIFE : POT.* SWITCH | 25.000 (10-15 CPM) 10.000 (1 A, 50 VAC) | ±3 % (Rn < 1 MΩ) |
| TEMPERATURE COEFFICIENT | -25°C; +70°C | ±300 ppm/°C (Rn < 100 KΩ) |
| THERMAL CYCLING | 16 h. @ 85°C; 2h. @ -25°C | ±2.5 % |
| DAMP HEAT | 500 h. @ 40°C @ 95% HR | ±5 % |
| VIBRATION (for each plane X,Y,Z) | 2 h. @ 10 Hz. ... 55 Hz. | ±2 % |

(*) only applicable to values ≥1K. For lower values please consult.

SWITCH

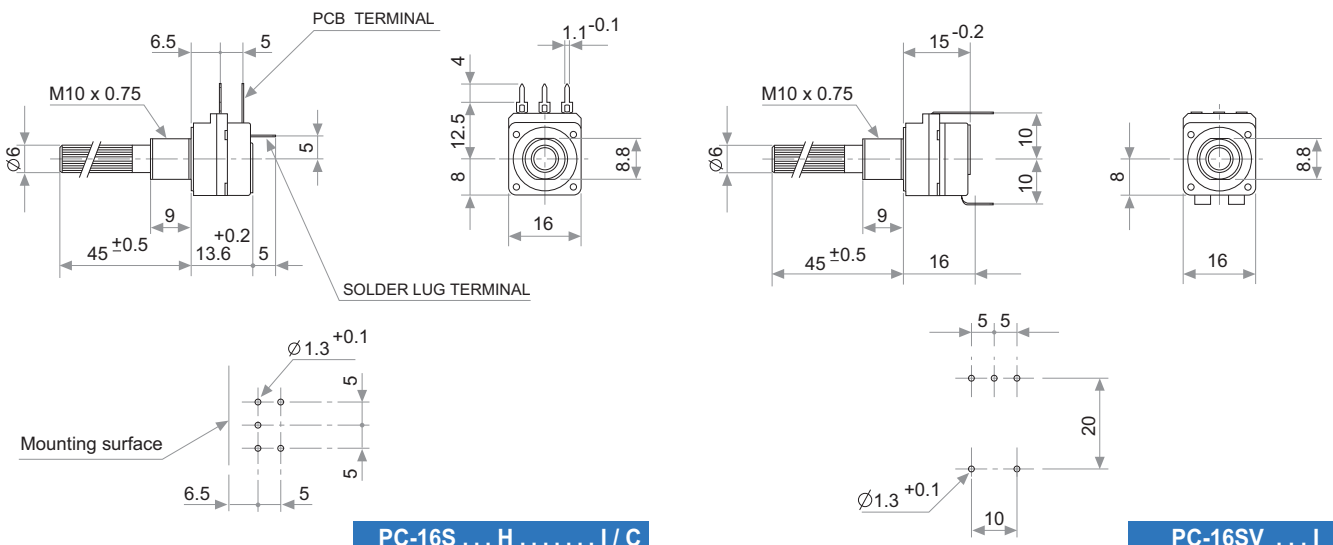

SWITCH SPECIFICATIONS

| | |
|------------------------------|-------------------------------|
| NOMINAL CURRENT | 1A, 250 VAC |
| CONTACT RESISTANCE (initial) | 10 mΩ |
| OPERATING TORQUE | 1 to 3 Ncm (1.4 to 4.2 in oz) |
| OPERATING ANGLE | 30° ± 5° |
| TEST VOLTAGE | 500 V |

PACKAGING

Boxes of 100 pieces (single body model): Inner dimensions 250 x 160 x 95 mm

METALIC SHAFTS

STANDARD

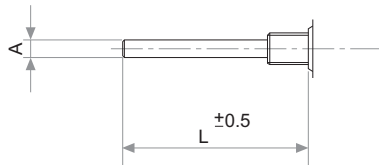

| A | L | CODE |
|------|----|------|
| 4 | 45 | M04 |
| 6 | 45 | M06 |
| 6.35 | 45 | M07 |

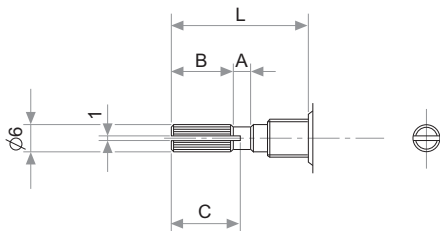

| A | B | C | L | CODE |
|---|----|----|----|------|
| 2 | 5 | 7 | 15 | M11 |
| 2 | 10 | 11 | 20 | M12 |
| 4 | 12 | 14 | 25 | M13 |
| 4 | 12 | 14 | 30 | M14 |
| 4 | 12 | 14 | 35 | M15 |
| 4 | 12 | 14 | 40 | M16 |
| 4 | 12 | 14 | 45 | M17 |

SPECIAL

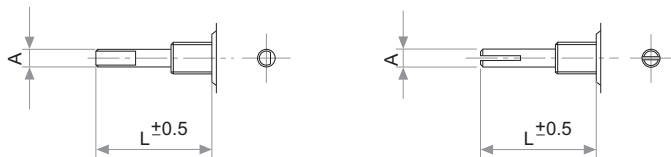

| A |
|------|
| 4 |
| 6 |
| 6.35 |

PLASTIC SHAFTS Ø3.1

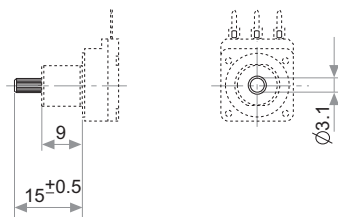

P09

PLASTIC SHAFTS Ø4



PLASTIC SHAFTS Ø4

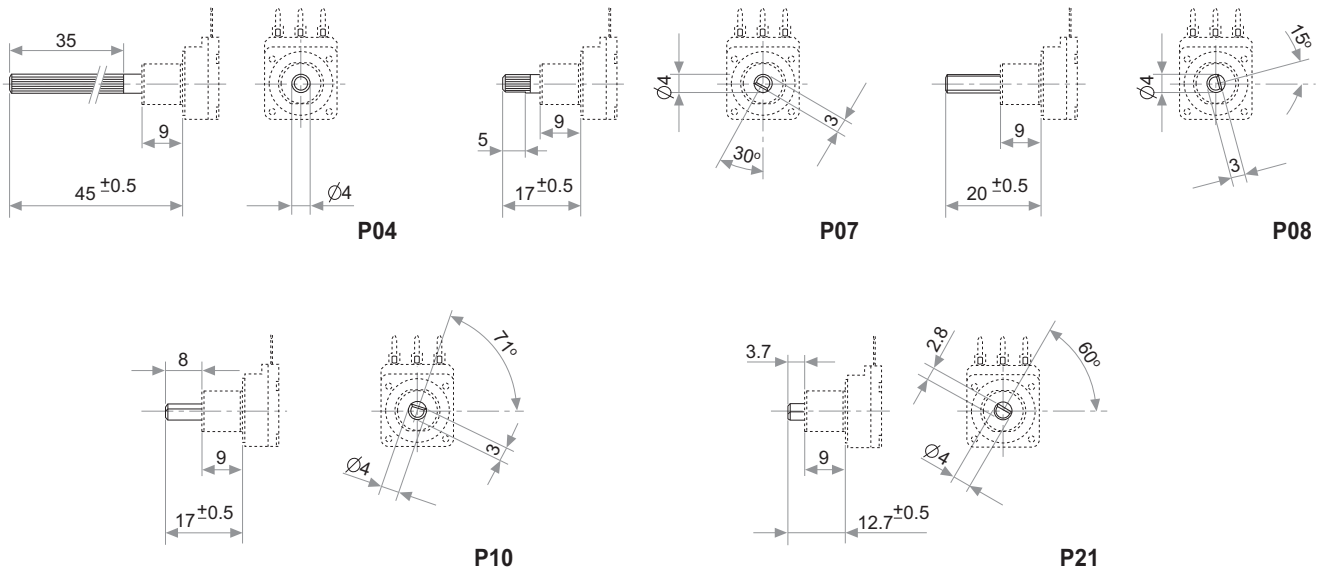

PLASTIC SHAFTS Ø6

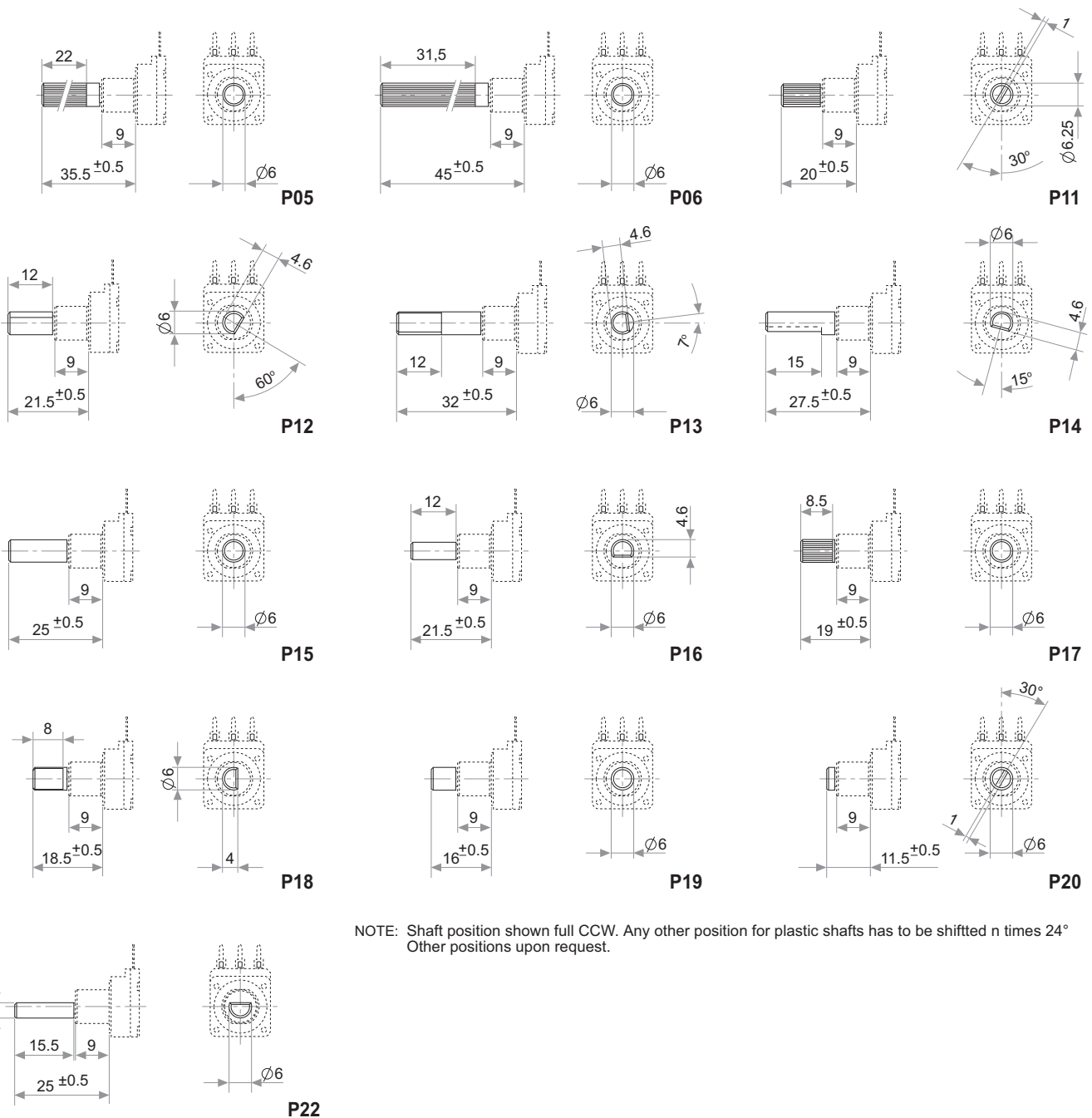

NOTE: Shaft position shown full CCW. Any other position for plastic shafts has to be shifted n times 24° . Other positions upon request.